

PRODUCT SPECIFICATION

MODEL NO	HD09VR Highbay Series
INPUT	12VDC
DESCRIPTION	HIGHBAY PIR SENSOR SERIES (BLUETOOTH & REGULAR)
VERSION	V3.0

HIGHBAY PIR SENSOR SERIES (BLUETOOTH & REGULAR)



DONGGUAN HAIYUE INTELLIGENT TECHNOLOGY CO.,LTD

13th Floor, C1 Building, Songshan Lake Intelligent Valley,

Liaobu Town, Dongguan City, 523808, Guangdong.

Contact us info@haisensz.com

www.haisensz.com

Series Work of Art

All Rights Reserved by HAISEN

WRITTEN BY	夏勇
CHECKED BY (R&D)	陈启东
CONFIRMED BY (SALES)	周蒙
DATE	2023.09.23

Features & Benefits



HD09VR Highbay Series

- Rotator & Remote control, app control for BLE version.
- 12VDC Input, 0-10V Dimming, with Daylight Harvesting and Photocell Function.
- ONE for ALL Installations Partnering With Different Receptacles & Brackets.

Demensions Unit:mm

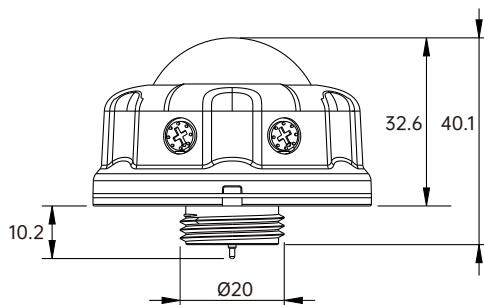
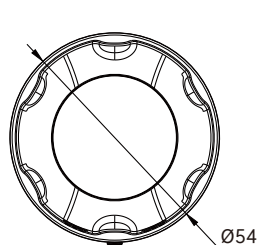

HD09VR-PH/HD09VR-PHB

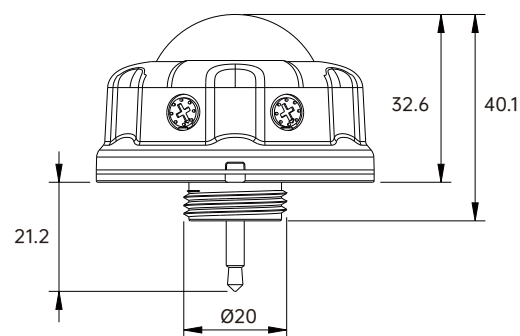

HD09VR-PH-1/HD09VR-PHB-1

Wiring Diagram

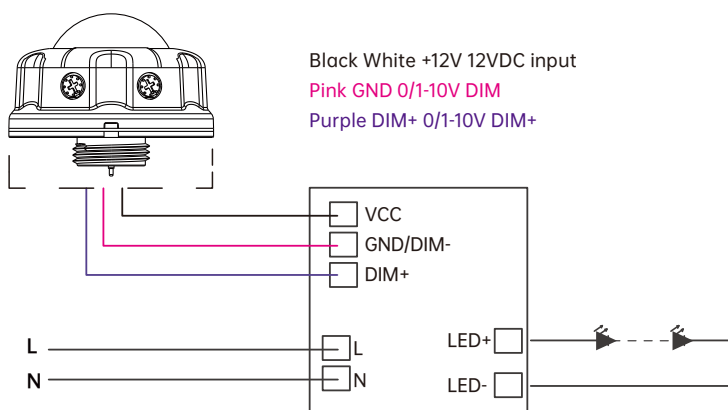

Model Information

Model Number	Sensor Type	Connector	Controller
HD09VR-PH	PIR	3-Pin	Remote Control HD05R
HD09VR-PH-1		Audio Jack	
HD09VR-PHB		3-Pin	HAISEN BLUE APP
HD09VR-PHB-1		Audio Jack	

Parameters

Model NO.		HD09VR
PIR INFORMATION	Infrared Wavelength	5-14um
	Output Signal Peak	≥3500mV
	PIR Sensitivity	3200V/W
	Installation Height	12m/39ft Max.
	Detection Distance	≥3m/9ft
	Detection Angle	Fresnel Lens ≤120° Fresnel Lens
	Warranty	3 Years
SENSOR PARAMETER	Detection Area	Remote Control: 25%/50%/75%/100% Rotating switch: Default Setting 100% APP Control Options: 25%/50%/75%/100%
	Holdtime	Remote Control: 5s/30s/1min/3min/5min/10min/20min/30min Rotating switch: 5s/1min/5min/10min APP Control Options: 5s/ 30s/ 1min/ 2min/ 3min/ 5min/ 10min/ 15min/ 20min/ 25min/30min/ 45min/ 60min/ 90min/ 120min
	Daylight Threshold	Remote Control: 2Lux/10Lux/30Lux/50Lux/80Lux/120Lux/200Lux/250Lux/300Lux/350Lux/400Lux/Disable Rotating switch: Default Setting Disable APP Control Options: 2Lux/10Lux/30Lux/50Lux/80Lux/120Lux/200Lux/250Lux/300Lux/350Lux/400Lux/Disable
	Standby Dimming Level	Remote Control: 10%/20%/30%/50% Rotating switch: 0%/10%/30%/50% APP Control Options: 10%/20%/30%/50%
	Standby Period	Remote Control: 0s/10s/30s/1min/5min/10min/30min/60min/+∞ Rotating switch: Default Setting +∞ APP Control Options: 0s/5s/30s/1min/2min/3min/5min/10min/15min/20min/25min/30min/45min/60min/+∞
	Dusk/Dawn Sensing/ Photocell	Daylight threshold as 30lux/50lux/80lux/120lux/200Lux/ 250Lux/300Lux/350Lux/400Lux Standby period as +∞ ; Standby dimming level as 10%/20%/30%
	Daylight Harvesting	1. Adjust "daylight" value higher than 50lux 2. Preset "standby period" 0S 3. press MW/PIR button 3 times till MW/PIR icons both blinking on LCD screen, daylight harvesting function enabled. (With BLE version, press DH button, daylight harvesting function enabled.)
	Output	ON/OFF,0-10V Dimming
	Warm-up Period	45s
INPUT	Input Range	12VDC
	Voltage Range	10-15VDC
	Current	<30mA
OUTPUT	Signal	DIM 0-10V
ENVIRONMENT	Working Temp	-20°C~+60°C
	Storage Temp	-40°C~+80°C Humidity: 85% (non-condensation)
CERTIFICATE & STANDARDS	Environmental Requirements	In accordance with CE ROHS
	IP Rating	IP65

Receptacle Options

Type A

3 pogo-pin connection
 Wire color: Black/white, Pink, Purple
 The length of the wire: 330mm

HD07VRA-1

Audio Jack connection
 Wire color: Black/white, Pink, Purple
 The length of the wire: 330mm

Type A-3

3 pogo-pin connection
 Wire color: Yellow, Pink, Purple
 The length of the wire: 200mm

Type A-3-1

3 pogo-pin connection
 Wire color: Yellow, Pink, Purple
 The length of the wire: 300mm

Type B

3 pogo-pin connection
 Wire color: Black/white, Pink, Purple
 The length of the wire: 330mm

Type C

3 pogo-pin connection
 Wire color: Black/white, Pink, Purple
 The length of the wire: 300mm

Dial Rotator Function

HD09VR-PH Regular Version

- ① Holdtime
5s/1min/5min/10min
- ② Standby Dimming Level
0%/10%/30%/50%



Detection Area Default 100%	Daylight Threshold Default Disable	Standby Period Default as +∞ infinite with specific standby dim level.
--------------------------------	---------------------------------------	---

*Please note the regular version is remote control supported; the sensor memorizes the last-time setting.

HD09VR-PHB Bluetooth Version



Dial Rotator Not supported, only APP control

Detection Coverage

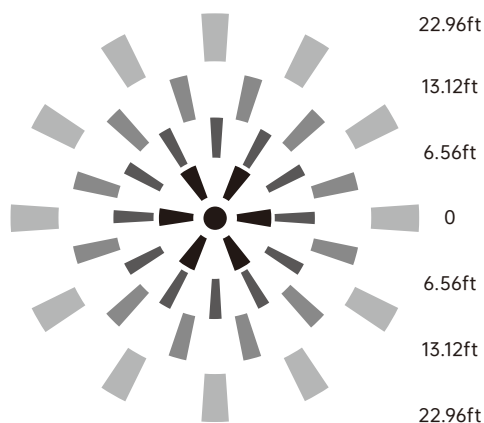

Mounting Height
<12m/39.37ft Ceiling Mounted

Detection Distance
Radius 3-7m/9.84-22.96ft

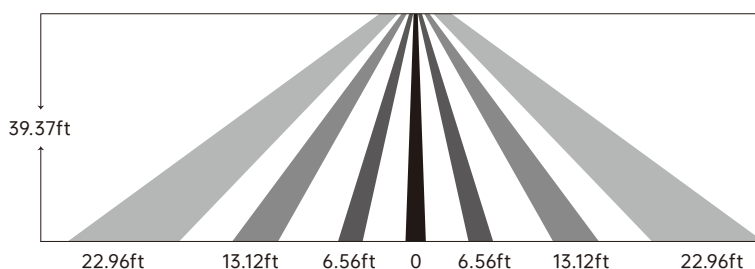

Performance

1. Daylight Harvesting

1. Adjust "daylight" value higher than 50lux
2. Preset "standby period" 0S
3. press MW/PIR button 3 times till MW/PIR icons both blinking on LCD screen, daylight harvesting function enabled.
(With BLE version, press DH button, daylight harvesting function enabled.)

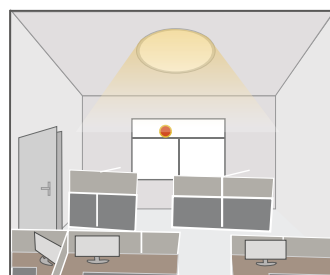
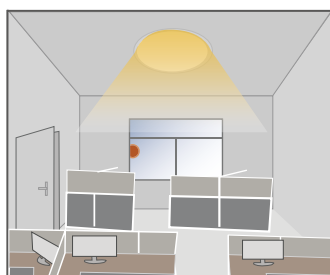
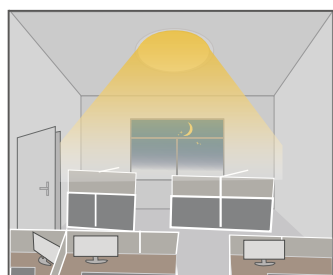
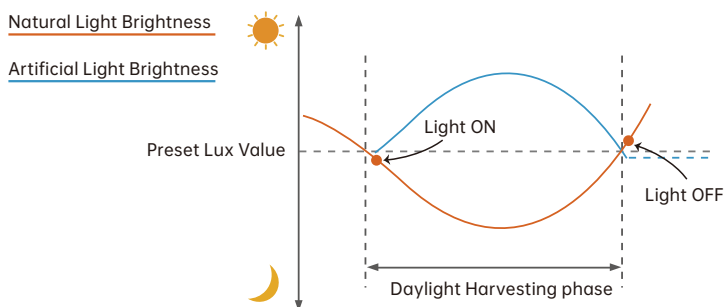

When ambient brightness is lower than preset lux level, sensor will turn on light automatically and keep dimming according to the change of the ambient brightness; when outside is getting darker, the inside will be brighter, and brighter darker.

Light OFF when ambient brightness becomes higher than the preset lux level.

2. Dusk/Dawn function

HD09VR is able to differentiate artificial light brightness from natural light after installed inside the fixture, and automatically turn off light when ambient brightness exceeds preset lux level.

Precondition of Dusk/Dawn function:

1. Standby period is +∞;
2. Standby dimming level is on 10%, 20% or 30%;
3. Daylight threshold is on 30lux/50lux/80lux/120lux/200Lux/250Lux/300Lux/350Lux/400Lux

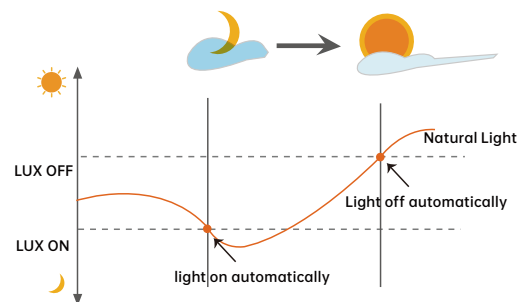

3. With Dusk/Dawn function

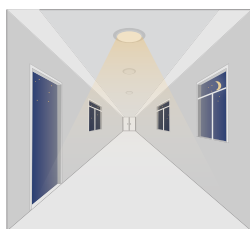

With insufficient ambient brightness, sensor turns on light and keeps it at standby dimming level even if there is no motion or presence.

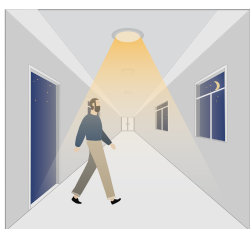

When sensor detects motion or presence it will bring the light level up to 100%.

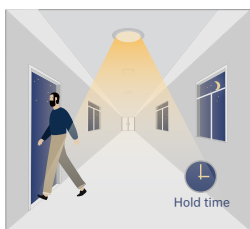

After motion is no longer detected, fixture remains at 100% for hold time.

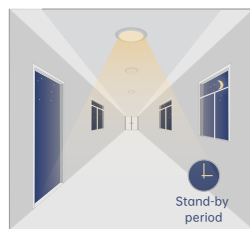

After pre-set hold time period it will dim light to standby dimming level again and always keep it.

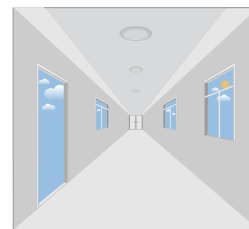

With sufficient ambient brightness, sensor will turn OFF light automatically.

4. Without daylight disabled

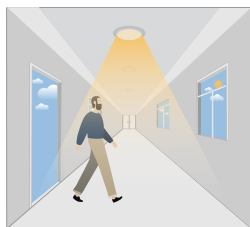

Sensor turns ON light when motion is detected.

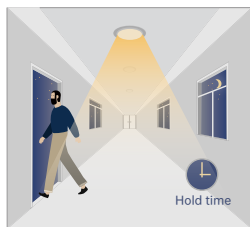

Sensor keeps for a hold time period after motion leaves

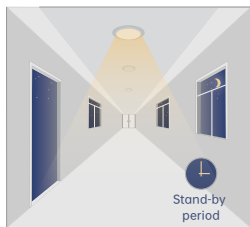

Sensor dims light to standby dimming level after hold time if there is still no motion

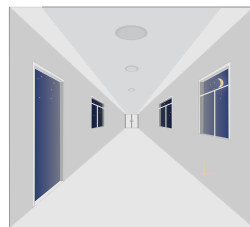

Sensor turns OFF light after standby period

5. With Daylight Threshold

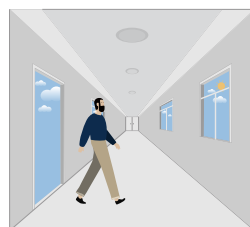

With sufficient daylight, the sensor keeps light OFF even motion gets detected

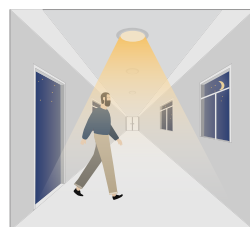

With insufficient daylight, the sensor turns light ON when motion gets detected

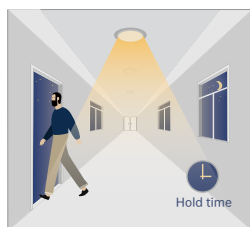

After there's no motion detected, the sensor keeps light ON 100% for holdtime.

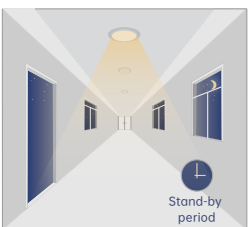

After holdtime, sensor dims light to standby dimming level for standby period. if the standby period has been set as 0s, sensor turns light OFF automatically after holdtime.

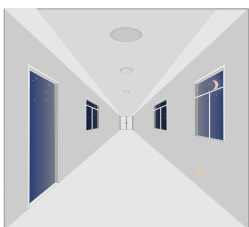

The sensor turns OFF light automatically after the standby period when there's no motion detected.



Attention

1. The sensor should be installed by qualified electrician and ensure power is OFF before installation.
2. Please read the instruction carefully before using the product and keep it well for other users to read any time.
3. We reserve the right to modify any incorrect text, image and technical parameters.
4. Any unauthorized modification is forbidden. Otherwise all guarantees will be immediately invalid.
5. Product could be optimized without prior notice.

* When ambient temperature approaches the human body classic temperature range (36°C ~37°C/96.8~98.6°F), PIR sensor's detecting performance will significantly weaken or non-responsive.

* When ambient temperature stays higher than 40°C/104°F, PIR sensor's detecting performance will significantly weaken.

APPLICATION NOTES

1. Suitable for indoor application, half/completely outdoor environment conditions might trigger the sensor.
2. Suitable for ceiling mount installation, adjust sensitivity properly if it's installed on side-wall because it gets more sensitive.
3. PIR sensor can't be placed inside any material, fresnel lens must completely exposed in air.
4. Fresnel lens of the PIR sensor must be lower than light fixture.
5. Not suitable environment if there's sudden changed temperature of airflow for PIR sensor.
6. Not suitable environment if there's shelves blocking between the sensor and presence area.
7. Detection area options may NOT working obviously because it works depends on fresnel lens, it's physically defined.
8. Detection distance performance works better when moving parallelly than moving towards to the sensor.
9. Daylight testing delivered in bright day without shadow or specially designed lampshade or lens.
10. Dimming performance differs when connected to different drivers; If the driver can't completely turn OFF, sensor can't either.
11. Input power voltage must be stable with float less than 10%.
12. The first time powered ON sensor, light will be ON 100% for about 45S then dims to standby level or OFF.
13. Distance detection is delivered by testing person about 165cm in open area as reference, the result differs by size and speed of moving objects, mounting height and real-life situation.